

TC-X

Exploded View Drawing and Parts List

Model: **CF-X50SHN**

Model Number: **1M00632MN**

The part list and exploded view drawing as attached below indicate the full list of parts for the above mentioned pump model.

When ordering parts take care to select the correct model pump and required parts. Also be aware that models may change over time as improvements are made so cross-referencing the pumps serial number assembly date and service code are also recommended.

If you require specific spare parts you can also use this form to place your order.

For more information specific to your pump please refer to the pumps Service Book and Operation Manual available separately.

Please contact your Pump Distributor directly for more information.

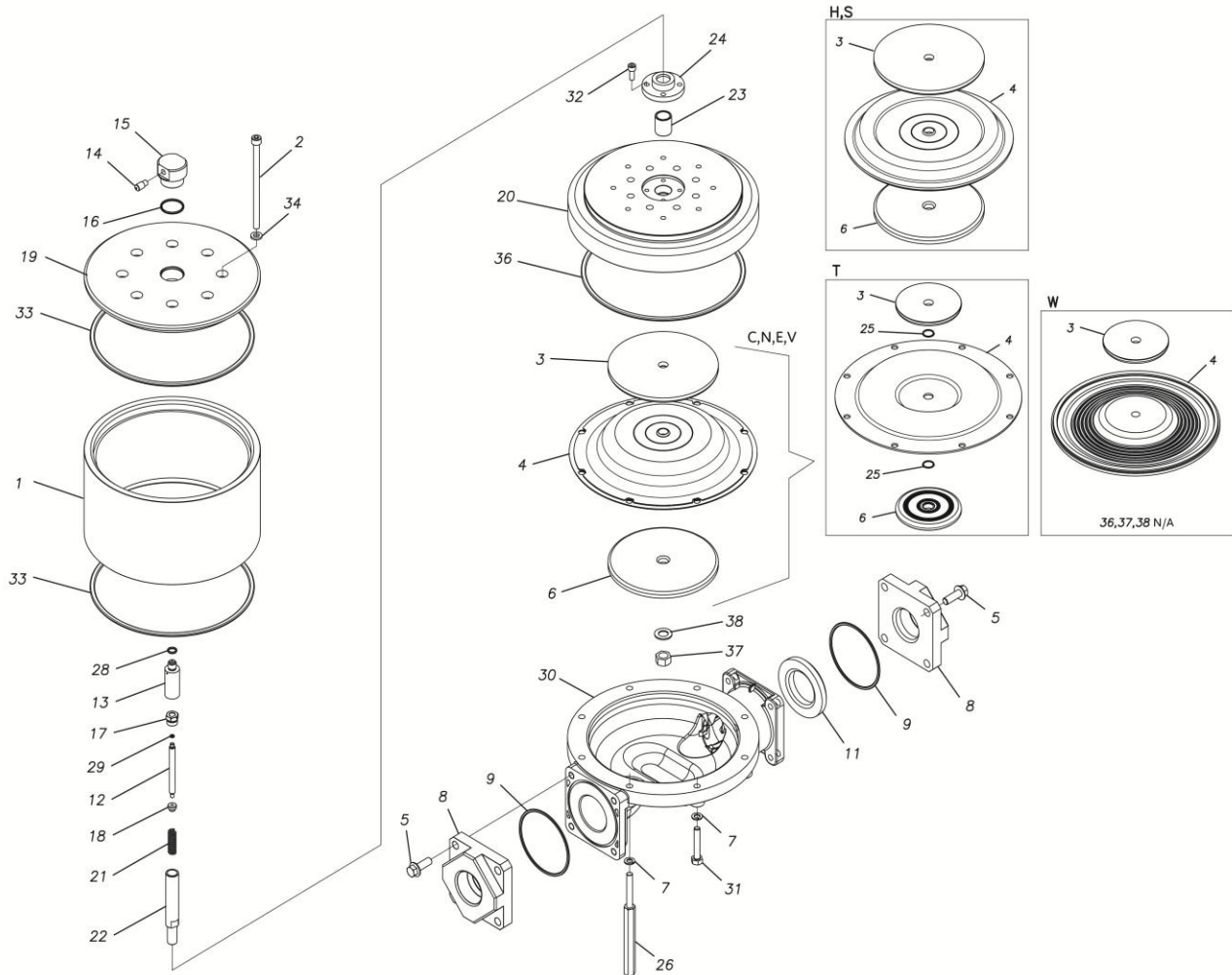

■ Parts List

CF-X50SHN

1M00632MN

Ref.No.	Parts No.	Description	Parts Component	Remark
1	1M30044MM	AIR CHAMBER	1	
2	9B3291001	BOLT M10 × 170	8	
3	1M20021MM	CENTER DISK	1	
4	1M20046HB	DIAPHRAGM	1	
5	9B2211235	BOLT M12 × 35	8	
6	1M20030MM	CENTER DISK	1	
7	9W4211000	SPRING LOCK WASHER M10	8	
8	1M20040SN	FLANGE	2	
9	9S1BG0115	O RING G-115	2	
11	1M20012BB	VALVE SEAT	1	
12	1M30045MM	VALVE	1	
13	1M30046MM	VALVE SEAT	1	
14	1D90004MN	SILENCER	1	
15	1M10011MN	VALVE ASSEMBLY	1	
16	9S1BG0035	O RING G-35	1	
17	1D30055MM	STOPPER CENTER ROD	1	
18	1D30056MM	STOPPER VALVE	1	
19	1M30047MM	AIR CHAMBER UPPER	1	
20	1M30048MM	AIR CHAMBER LOWER	1	
21	1D30059MM	SPRING	1	
22	1M20042MM	CENTER ROD	1	
23	1D30060MM	BEARING CENTER ROD	1	
24	1H30124MM	CASE BEARING	1	
26	1M30049MM	STUD	4	

Ref.No.	Parts No.	Description	Parts Component	Remark
28	9S1BP0012	O RING P-12	1	
29	9S1B90008	O RING P-4	1	
30	1M20073SM	OUT CHAMBER	1	
31	9B1221060	BOLT M10 × 60	4	
32	9B3410820	BOLT M8 × 20	4	
33	9S1BM0270	O RING GS-270	2	
34	1H30127MB	SEAL WASHER	8	
36	9S1BG0270	O RING G-270	1	
37	9N1731600	NUT M16 × 1.5	1	
38	9W3311600	CONED DISK SPRING M16	1	