

TC-X

Exploded View Drawing and Parts List

Model: **TC-X400SNA**

Model Number: **1L00528MN**

The part list and exploded view drawing as attached below indicate the full list of parts for the above mentioned pump model.

When ordering parts take care to select the correct model pump and required parts. Also be aware that models may change over time as improvements are made so cross-referencing the pumps serial number assembly date and service code are also recommended.

If you require specific spare parts you can also use this form to place your order.

For more information specific to your pump please refer to the pumps Service Book and Operation Manual available separately.

Please contact your Pump Distributor directly for more information.

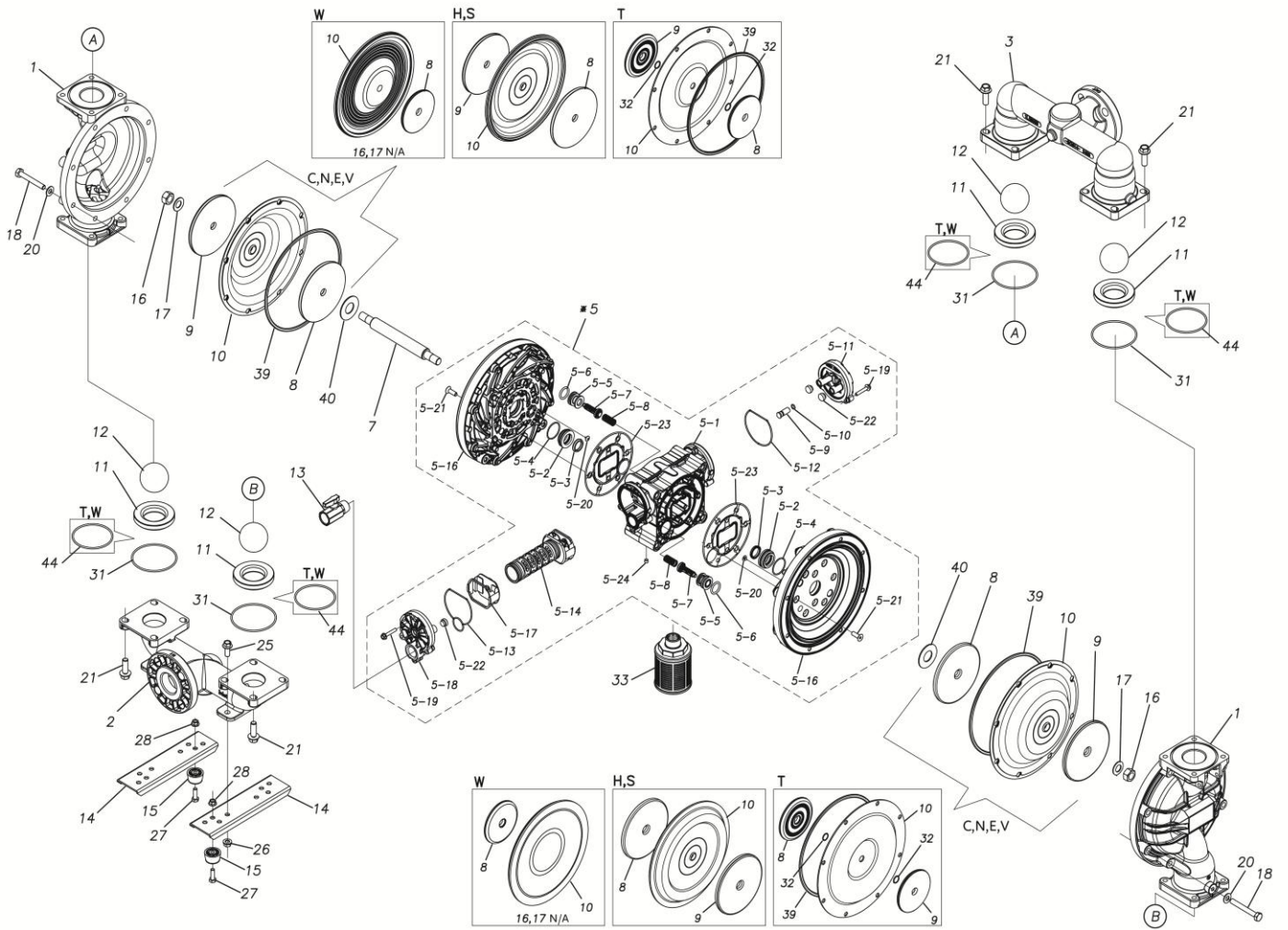

■ Parts List

TC-X400SNA

1L00528MN

Ref.No.	Parts No.	Description	Parts Component	Remark
1	1L20072SM	OUT CHAMBER	2	
2	1L20068SU	IN MANIFOLD	1	
3	1L20069SU	OUT MANIFOLD	1	
5	1L10023MN	BODY ASSEMBLY	1	

Ref.No.	Parts No.	Description	Parts Component	Remark
5-1	1L30054MN	BODY	1	The parts of #5 are available with a set as [1L10023MN: BODY ASSEMBLY]. This is also available individually.
5-2	1M30026MM	BEARING CENTER ROD	2	
5-3	9S2BA0025	PACKING	2	
5-4	9S1BS0036	O RING S-36	2	
5-5	1L30063MM	PILOT VALVE SEAT	2	
5-6	9S1BP1022	O RING P-22A	2	
5-7	1L30058MB	PILOT VALVE	2	
5-8	1L30064MM	SPRING	2	
5-9	1L30065MM	RESET BUTTON	1	
5-10	9S1BP0008	O RING P-8	1	
5-11	1L30056MB	CAP	1	
5-12	1L30061MB	PACKING CAP	1	
5-13	1L30060MB	PACKING CAP IN	1	
5-14	1L10003MK	C SPOOL VALVE ASSEMBLY (Looped C®)	1	
5-16	1L30066MM	AIR CHAMBER	2	
5-17	1L30005MB	SPRING STOPPER	1	
5-18	1L30055MN	CAP IN	1	
5-19	9B2210635	BOLT M6 × 35	7	
5-20	9T6125008	SCREW M5 × 8	8	
5-21	9B5290800	BOLT M8 × 25	16	
5-22	1L30062MB	CUSHION	4	
5-23	1L30059MB	PACKING BODY	2	
5-24	9P62P9901	PLUG	2	
7	1L20043MM	CENTER ROD	1	
8	1L20019MM	CENTER DISK	2	
9	1L20040MM	CENTER DISK	2	
10	1L20002BB	DIAPHRAGM	2	
11	1L20037BB	VALVE SEAT	4	
12	1M20018BB	BALL	4	
13	1M90001MN	BALL VALVE	1	
14	1L30067MM	BASE	2	
15	1H30055MB	RUBBER FEET	4	
16	9N1731600	NUT M16 × 1.5	2	
17	9W3311600	CONED DISK SPRING M16	2	
18	9B1221060	BOLT M10 × 60	16	
20	9W4211000	SPRING LOCK WASHER M10	16	
21	9B2211235	BOLT M12 × 35	16	
25	9B2211020	BOLT M10 × 20	4	
26	9N2211000	NUT M10	4	
27	9B1110825	BOLT M8 × 25	4	
28	9N2110800	NUT M8	4	
31	9S1BG0100	O RING G-100	4	
33	1L90002MN	SILENCER	1	
39	9S1BG0230	O RING G-230	2	
40	1M30033MB	CUSHION CENTER DISK	2	