

TC-X

Exploded View Drawing and Parts List

Model: **CF-X15PHN**

Model Number: **1E00315MN**

The part list and exploded view drawing as attached below indicate the full list of parts for the above mentioned pump model.

When ordering parts take care to select the correct model pump and required parts. Also be aware that models may change over time as improvements are made so cross-referencing the pumps serial number assembly date and service code are also recommended.

If you require specific spare parts you can also use this form to place your order.

For more information specific to your pump please refer to the pumps Service Book and Operation Manual available separately.

Please contact your Pump Distributor directly for more information.

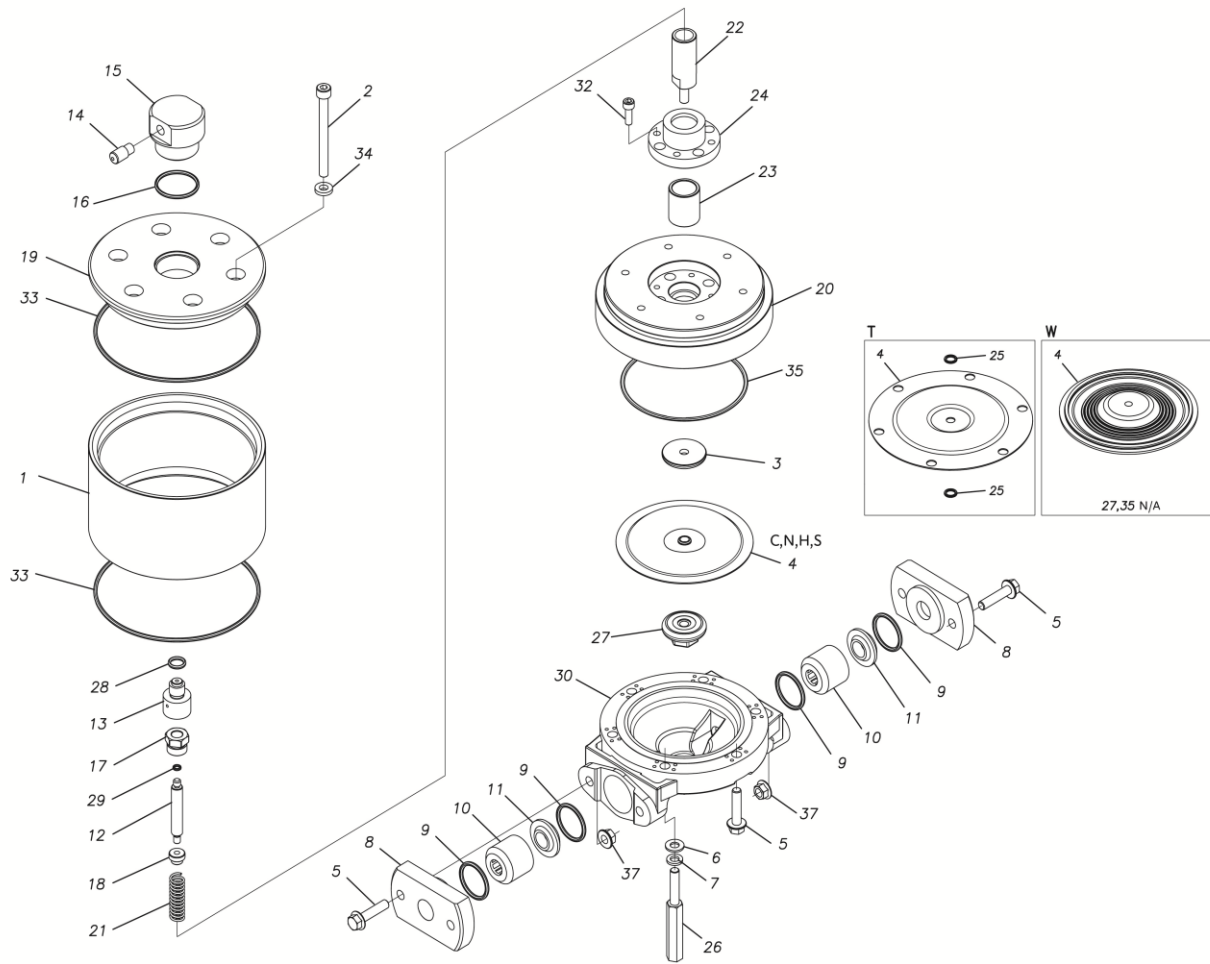

■ Parts List

CF-X15PHN

1E00315MN

Ref.No.	Parts No.	Description	Parts Component	Remark
1	1E30081MM	AIR CHAMBER	1	
2	9B3220885	BOLT M8 × 85	6	
3	1E20024AM	CENTER DISK	1	
4	1E20081HB	DIAPHRAGM	1	
5	9B2210835	BOLT M8 × 35	6	
6	9W1210800	PLAIN WASHER M8	4	
7	9W2210800	SPRING LOCK WASHER M8	4	
8	1E20064PN	FLANGE	2	
9	9S1BP0029	O RING P-29	4	
10	1E20013PB	VALVE STOPPER	2	
11	1E20014PB	VALVE SEAT	2	
12	1E30083MM	VALVE	1	
13	1D30054MM	VALVE SEAT	1	
14	1D90004MN	SILENCER	1	
15	1D10018MN	VALVE ASSEMBLY	1	
16	9S1BG0035	O RING G-35	1	
17	1D30055MM	STOPPER CENTER ROD	1	
18	1D30056MM	STOPPER VALVE	1	
19	1E30084MM	AIR CHAMBER UPPER	1	
20	1E30085MM	AIR CHAMBER LOWER	1	
21	1D30059MM	SPRING	1	
22	1D20048MM	CENTER ROD	1	
23	1D30060MM	BEARING CENTER ROD	1	
24	1D30061MM	CASE BEARING	1	

Ref.No.	Parts No.	Description	Parts Component	Remark
26	1E30086MM	STUD	4	
27	1E20034PB	CENTER DISK	1	
28	9S1BP0012	O RING P-12	1	
29	9S1B90008	O RING P-4	1	
30	1E20076PB	OUT CHAMBER	1	
32	9B3410618	BOLT M6 × 18	4	
33	9S1BG0145	O RING G-145	2	
34	1D30077MB	SEAL WASHER	6	
35	9S1BG0110	O RING G-110	1	
37	9N2210800	NUT M8	4	