

TC-X

Exploded View Drawing and Parts List

Model: **CF-X40SH**

Model Number: **1L00596MP**

The part list and exploded view drawing as attached below indicate the full list of parts for the above mentioned pump model.

When ordering parts take care to select the correct model pump and required parts. Also be aware that models may change over time as improvements are made so cross-referencing the pumps serial number assembly date and service code are also recommended.

If you require specific spare parts you can also use this form to place your order.

For more information specific to your pump please refer to the pumps Service Book and Operation Manual available separately.

Please contact your Pump Distributor directly for more information.

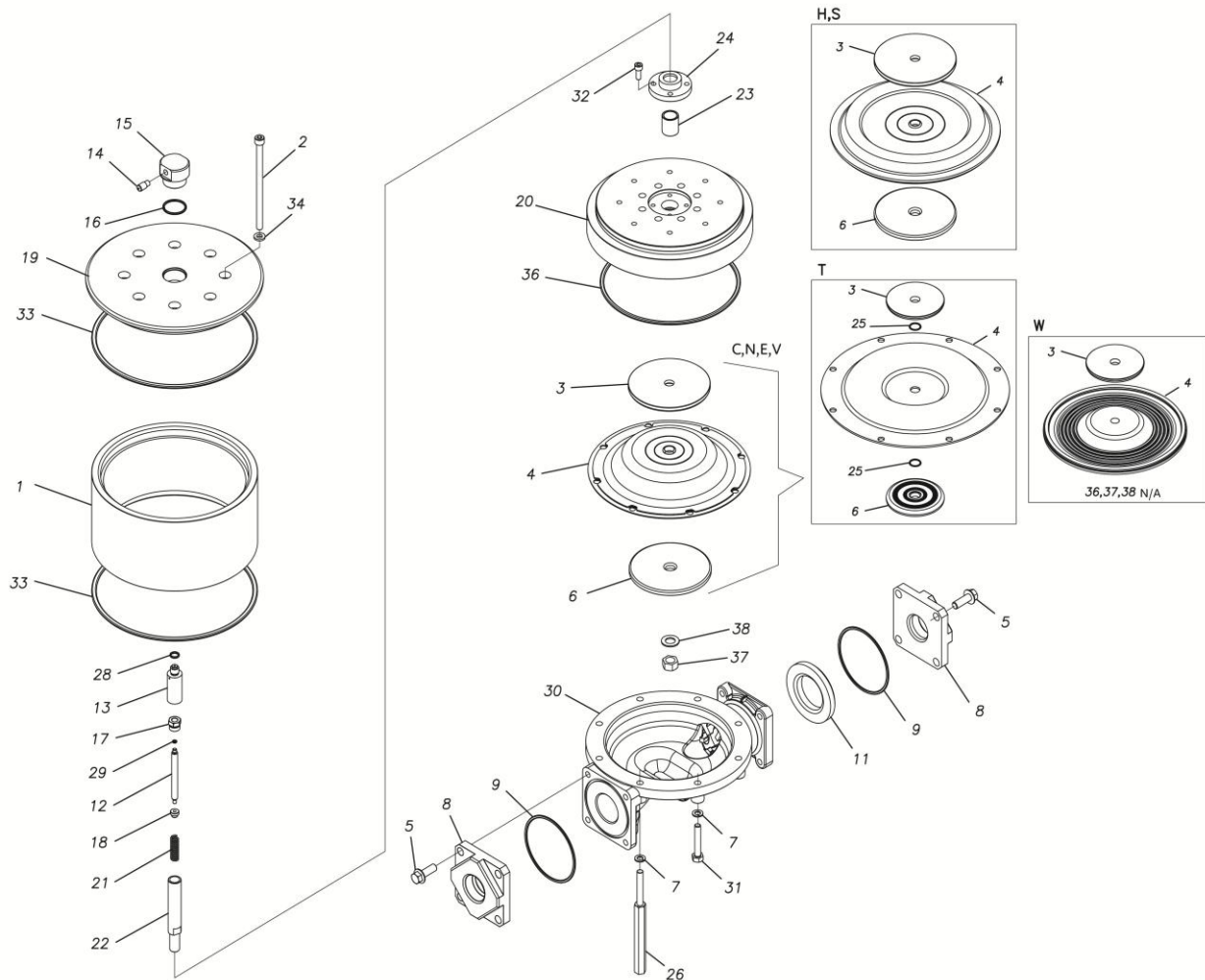

■ Parts List

CF-X40SH

1L00596MP

Ref.No.	Parts No.	Description	Parts Component	Remark
1	1L30068MM	AIR CHAMBER	1	
2	9B3291002	BOLT M10 × 140	8	
3	1L20019MM	CENTER DISK	1	
4	1L20051HB	DIAPHRAGM	1	
5	9B2211235	BOLT M12 × 35	8	
6	1L20040MM	CENTER DISK	1	
7	9W4211000	SPRING LOCK WASHER M10	8	
8	1L20048SP	FLANGE	2	
9	9S1BG0100	O RING G-100	2	
11	1L20037BB	VALVE SEAT	1	
12	1M30045MM	VALVE	1	
13	1M30046MM	VALVE SEAT	1	
14	1D90004MP	SILENCER	1	
15	1M10011MP	VALVE ASSEMBLY	1	
16	9S1BG0035	O RING G-35	1	
17	1D30055MM	STOPPER CENTER ROD	1	
18	1D30056MM	STOPPER VALVE	1	
19	1L30069MM	AIR CHAMBER UPPER	1	
20	1L30070MM	AIR CHAMBER LOWER	1	
21	1D30059MM	SPRING	1	
22	1L20046MM	CENTER ROD	1	
23	1D30060MM	BEARING CENTER ROD	1	
24	1H30124MM	CASE BEARING	1	
26	1L30071MM	STUD	4	

Ref.No.	Parts No.	Description	Parts Component	Remark
28	9S1BP0012	O RING P-12	1	
29	9S1B90008	O RING P-4	1	
30	1L20072SM	OUT CHANBER	1	
31	9B1221060	BOLT M10 × 60	4	
32	9B3410820	BOLT M8 × 20	4	
33	9S1BM0250	O RING GS-250	2	
34	1H30127MB	SEAL WASHER	8	
36	9S1BG0230	O RING G-230	1	
37	9N1731600	NUT M16 × 1.5	1	
38	9W3311600	CONED DISK SPRING M16	1	