

TC-X

Exploded View Drawing and Parts List

Model: **CF-X25SE**

Model Number: **1H00555MP**

The part list and exploded view drawing as attached below indicate the full list of parts for the above mentioned pump model.

When ordering parts take care to select the correct model pump and required parts. Also be aware that models may change over time as improvements are made so cross-referencing the pumps serial number assembly date and service code are also recommended.

If you require specific spare parts you can also use this form to place your order.

For more information specific to your pump please refer to the pumps Service Book and Operation Manual available separately.

Please contact your Pump Distributor directly for more information.

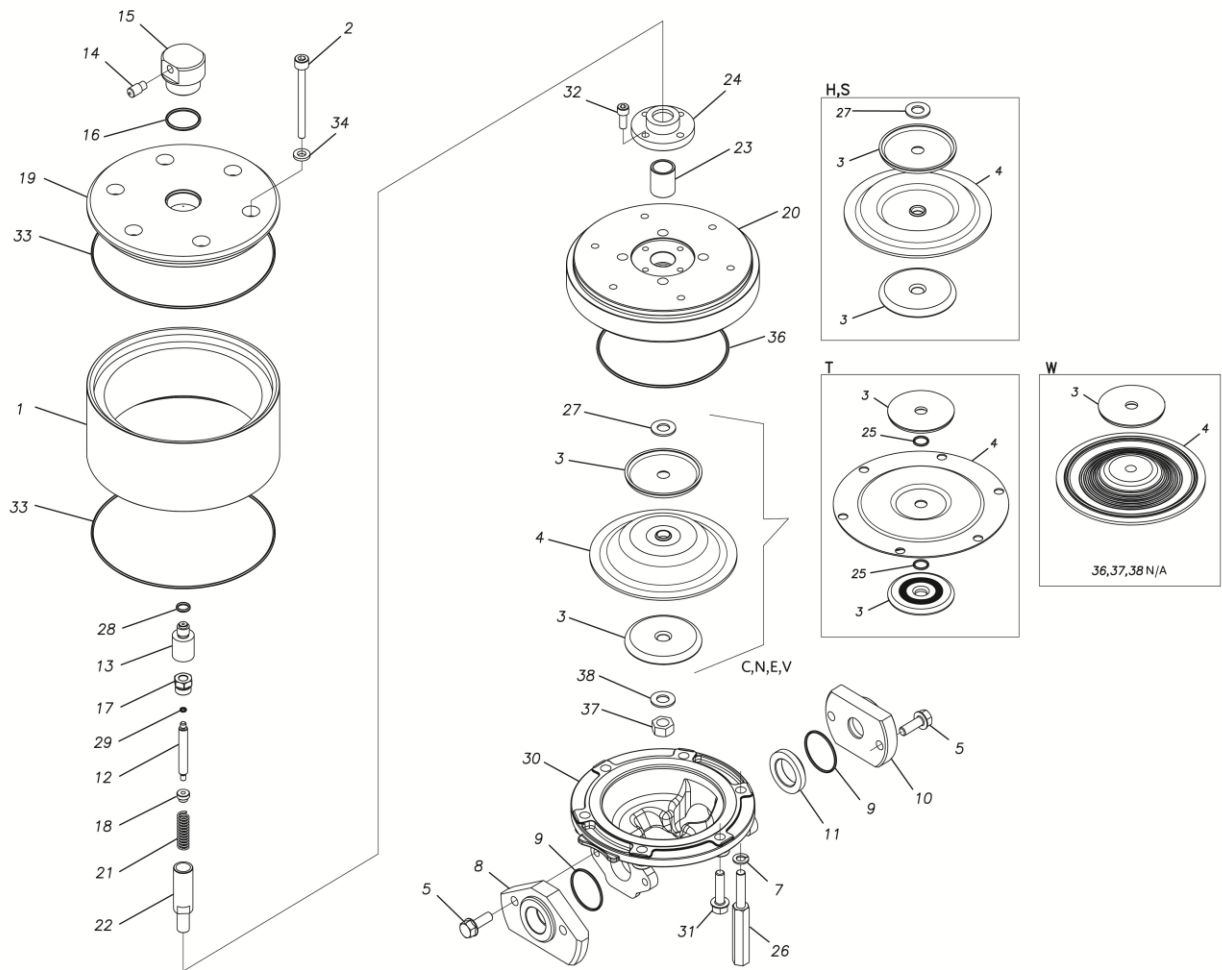

■ Parts List

CF-X25SE

1H0055MP

Ref.No.	Parts No.	Description	Parts Component	Remark
1	1H30117MM	AIR CHAMBER	1	
2	9B3221095	BOLT M10 × 95	6	
3	1H20022MM	CENTER DISK	2	
4	1H20084EB	DIAPHRAGM	1	
5	9B2211030	BOLT M10 × 30	4	
7	9W4211000	SPRING LOCK WASHER M10	2	
8	1H20083SP	FLANGE OUT	1	
9	9S1EG0045	O RING G-45	2	
10	1H20082SP	FLANGE IN	1	
11	1H20103SM	SEAT	1	
12	1H30119MM	VALVE	1	
13	1H30120MM	VALVE SEAT	1	
14	1D90004MP	SILENCER	1	
15	1H10040MP	VALVE ASSEMBLY	1	
16	9S1BG0035	O RING G-35	1	
17	1D30055MM	STOPPER CENTER ROD	1	
18	1D30056MM	STOPPER VALVE	1	
19	1H30121MM	AIR CHAMBER UPPER	1	
20	1H30122MM	AIR CHAMBER LOWER	1	
21	1D30059MM	SPRING	1	
22	1H20088MM	CENTER ROD	1	
23	1D30060MM	BEARING CENTER ROD	1	
24	1H30124MM	CASE BEARING	1	
26	1H30118MM	STUD	2	

Ref.No.	Parts No.	Description	Parts Component	Remark
27	9W1211400	WASHER M14	1	
28	9S1BP0012	O RING P-12	1	
29	9S1B90008	O RING P-4	1	
30	1H20119SM	OUT CHAMBER	1	
31	9B2211040	BOLT M10 × 40	4	
32	9B3410820	BOLT M8 × 20	4	
33	9S1BM0205	O RING GS-205	2	
34	1H30127MB	SEAL WASHER	6	
36	9S1BG0145	O RING G-145	1	
37	9N1311400	NUT M14 × 1.5	1	
38	9W3311400	CONED DISK SPRING M14	1	